



DATOS MOTOR

POTENCIA	15HP
REVOLUCIONES	1760
FRECUENCIA	60HZ
TORQUE MOTOR NOMINAL	59,7
CARCASA (PAM)	132(B5)
TIPO BRIDA	FF-265
EFICIENCIA MOTOR	IE 2

DATOS REDUCTOR

REFERENCIA	550026
TIPO	ORTOGONAL
MODELO	FCNDK
MATERIAL	HIERRO
CARCASA	110
RELACION DE TRANSMISION i:	15
VELOCIDAD SALIDA	117,33
TORQUE MAXIMO	660
TORQUE OPERACIÓN	770
FACTOR DE SERVICIO	0,9

PLANOS REDUCTOR

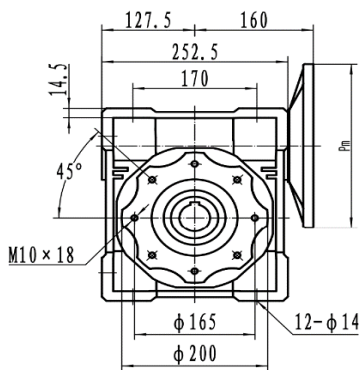

FCN 110

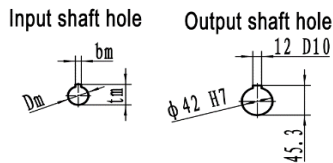

	Pm	Dm	bm	tm
80B5	200	19	6	21.8
90B5	200	24	8	27.3
90B14	140			
100/112B5	250	28	8	31.3
100/112B14	160			
132B5	300	38	10	41.3
132B14	200			

